

A I R O P E R A T E D D O U B L E D I A P H R A G M P U M P S

**QBY**

**气动隔膜泵**

**AIR OPERATED DOUBLE DIAPHRAGM  
PUMPS**

上海民泉泵业有限公司

**上海民泉泵业有限公司**

地址：上海市交通西路48号 电话：021-36523279 网址：<http://www.minquan021.com>



## 目 录

性能简介	1
工作原理	2
主要用途	3
系统连接示意图	3
性能曲线图	4-7
安装尺寸图	8
安装尺寸表	8
性能参数	9
安装方式	9
爆炸图	10
零件清单	11-12
几种隔膜材料特性	13

上海民泉泵业有限公司

## Table of contents

Performance summary	1
Working principle	2
Main usage	3
System connection schematic diagram	3
Performance graph	4-7
Drawing of setting data	8
Tables of setting data	8
Performance parameter	9
Installation method	9
Exploded	10
Databook of sections	11-12
Characteristic of diaphragm	13



## 性能简介 Performance summary

QBY气动隔膜泵既能抽送流动的液体，又能输送一些不易流动的介质，具有自吸泵、潜水泵、屏蔽泵、泥浆泵和杂质泵等输送机械的许多优点。

- 1、不需灌引水，吸程高达7m，扬程达70m，出口压力 $\geq 6\text{kgf/cm}^2$ ；
- 2、流动宽敞，通过性能好，允许通过最大颗粒直径达10mm。抽送泥浆、杂质时，对泵磨损甚微；
- 3、扬程、流量可通过气阀开度实现无级调节(气压调节在1-7kgf/cm<sup>2</sup>之间)；
- 4、该泵无旋转部件，没有轴封，隔膜将抽送的介质与泵的运动部件、工件介质完全隔开，所输送的介质不会向外泄漏。所以抽送有毒、易挥发或腐蚀性介质时，不会造成环境污染和危害人身安全；
- 5、不必用电，在易燃、易爆场所使用安全可靠；
- 6、可以浸没在介质中工作；
- 7、使用方便、工作可靠、开停只需简单地打开和关闭气体阀门，即使由于意外情况而长时间无介质运行或突然停机，泵也不会因此而损坏。一旦超负荷，泵会自地动停机，具有自我保护性能，当负荷恢复正常后，又能自动启动运行；
- 8、结构简单、易损件少，该泵结构简单，安装、维修方便，泵输送的介质不会接触到配气阀，联杆等运动部件，不象其他类型的泵因转子、活塞、齿轮、叶片等部件的磨损而使性能逐步下降；
- 9、可输送较粘的液体(粘度在1万厘泊以下)；
- 10、本泵无须用油润滑，即使空转，对泵也无任何影响。这是该泵一大特点。

上海民泉泵业有限公司

QBY air operated double diaphragm pumps not only can exhaust the flow liquid, but also can convey some uneasy flowed medium, with the merits of self-pumping pump, diving pump, shield pump, slurry pump and impurity pump etc.

1. It's unnecessary to pour the drawing water, the suction lift reaches 7 m height, the delivery lift reaches 70 m length and the export pressure  $\geq 6\text{kgf/cm}^2$ ;
2. Wide flow and good performance. The diameter allowed to pass the max grain reaches 10mm. The damage is very less to the pump while exhausting the slurry and impurity.
3. The delivery lift and flow can pass the pneumatic valve open to realize the stepless adjustment (the pneumatic pressure adjustment is between 1-7kgf/cm<sup>2</sup>);
4. This pump has no rotary parts and no bearing seals. The diaphragm will completely separate the exhausted medium and pump running parts, working medium. The conveyed medium can't be leaked outside. Thus it will not cause the environmental pollution and human body safety dangerous while exhausting the toxin and flammable or corrosive medium.
5. No electricity. It's safe and reliable while using in the flammable and explore places.
6. It can be soaked in medium.
7. It's convenient to use and reliable to work. Only open or close the gas valve body while starting or stopping. Even if no medium operation or pausing suddenly for long time because of accident matters, the pump will not be damaged caused by this. Once over-loading, the pump will automatically stop and possesses the selfprotection function. When the load recovers normally, it also can start automatically.
8. Simple structure and less wearing parts. This pump is simple in structure, installation and maintenance. The medium conveyed by the pump will not touch the matched pneumatic valve and coupling lever etc. Not like other kinds pumps, the performance will drop down gradually because of the damages of rotor, gear and vane etc.
9. It can transmit the adhesive liquid (the viscosity is below 10000 centipoise).
10. This pump needn't the oil lubricant. Even if idling, it has any influence to the pump. This is a characteristic of this pump.



## 工作原理 Working principle

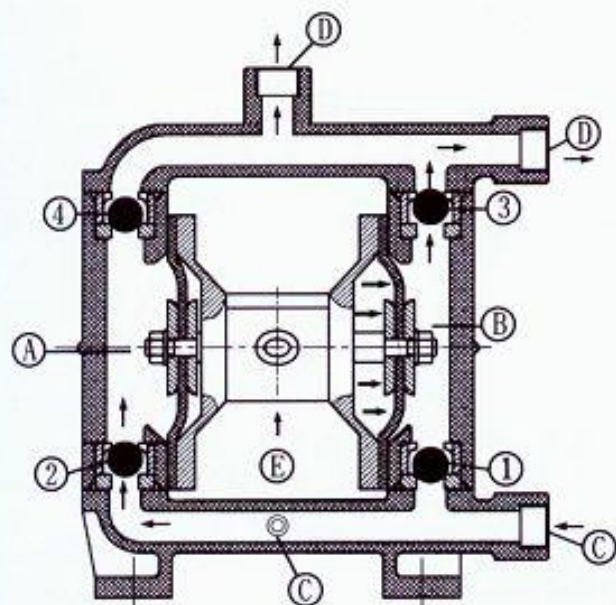

上海民泉泵业有限公司

在泵的两个对称工作腔中①、②中各装有一块隔膜，由中心联杆将其连结成一体。压缩空气从泵的进气口进入配气阀，通过配气机构将压缩空气引入其中一腔，推动腔中隔膜运动，而另一腔中气体排出。一旦到达行程终点，配气机构自动将压缩空气引入另一工作腔，推动隔膜朝相反方向运动，从而使两个隔膜连续同步地往复运动。

在图示中压缩空气由⑤进入配气阀，使膜片向右运动，则①室的吸力使介质由③入口流入，推开球阀②进入①室，球阀④则因吸入而闭锁；②室中的介质则被挤压，推开球阀③由出口④流出，同时使球阀①闭锁，防止回流，就这样循环往复使介质不断从③入口处吸入，④出口处排出。

There installs each diaphragm in both aligned working cavities (A)&(B), which can be connected together with a central coupling lever. The compression air enters the air distribution valve from the air entrance of the pump, draw the compression air into one cavity through the air distribution mechanism, push out the diaphragm movement in the cavity. The gas in another cavity will be drained. Once reaching the stroke terminal, the air distribution mechanism will automatically draw the compression air into another working cavity, push out the diaphragm to move towards the opposite direction, so as to let the both diaphragms continuously reciprocate motion in synchronism.

The compression air enters the air distribution valve from (E) shown as the diagram, let the diaphragm piece move towards the right direction. And the suction force in (A) chamber lets the medium flow into from (C) entrance, push out the ball valve (2) to enter (A) chamber, the ball valve (4) will be locked due to the suction force; The medium in (B) chamber will be pressed, push out the ball valve (3) to flow out from the exit (D). Meanwhile, let the ball valve (1) close, prevent backflow. Such movement in circles will let the medium uninterruptedly suck from (C) entrance and drain from (D) exit.

## 主要用途 Main usage

- 1、泵吸花生酱、泡菜、土豆泥、红肠、巧克力、啤酒花、糖浆等；
- 2、泵吸油漆、颜料、胶水、粘合剂等；
- 3、泵吸各种瓦、瓷、砖器及陶器釉浆等；
- 4、泵吸各种磨料、腐蚀剂、清洗油垢等；
- 5、泵吸各种剧毒、易燃、易挥发液体等；
- 6、泵吸各种污水、水泥灌浆及灰浆等；
- 7、泵吸各种强酸、强碱、强腐蚀液体等；
- 8、作为各种固液分离设备的前级送压装置。

- 1.The pump can suck the peanut,pickles,tomato slurry,red sausage,chocolate,hops and syrup etc.
- 2.The pump can suck the paint,pigment,glue and adhesive etc.
- 3.The pump can suck various glazed slurries of tile,porcelain,brick and chinaware etc.
- 4.The pump can suck various grinding materials,corrosive agent and clean the oil dirt etc.
- 5.The pump can suck various toxin and flammable or volatility liquid etc.
- 6.The pump can suck various wedge water,cement slurry and mortar etc.
- 7.The pump can suck various strong acid,alkali and corrosive liquid etc.
- 8.It can be used as a front-step transmission device of the solid and liquid separation equipment.

## 系统连接示意图 System connection schematic diagram

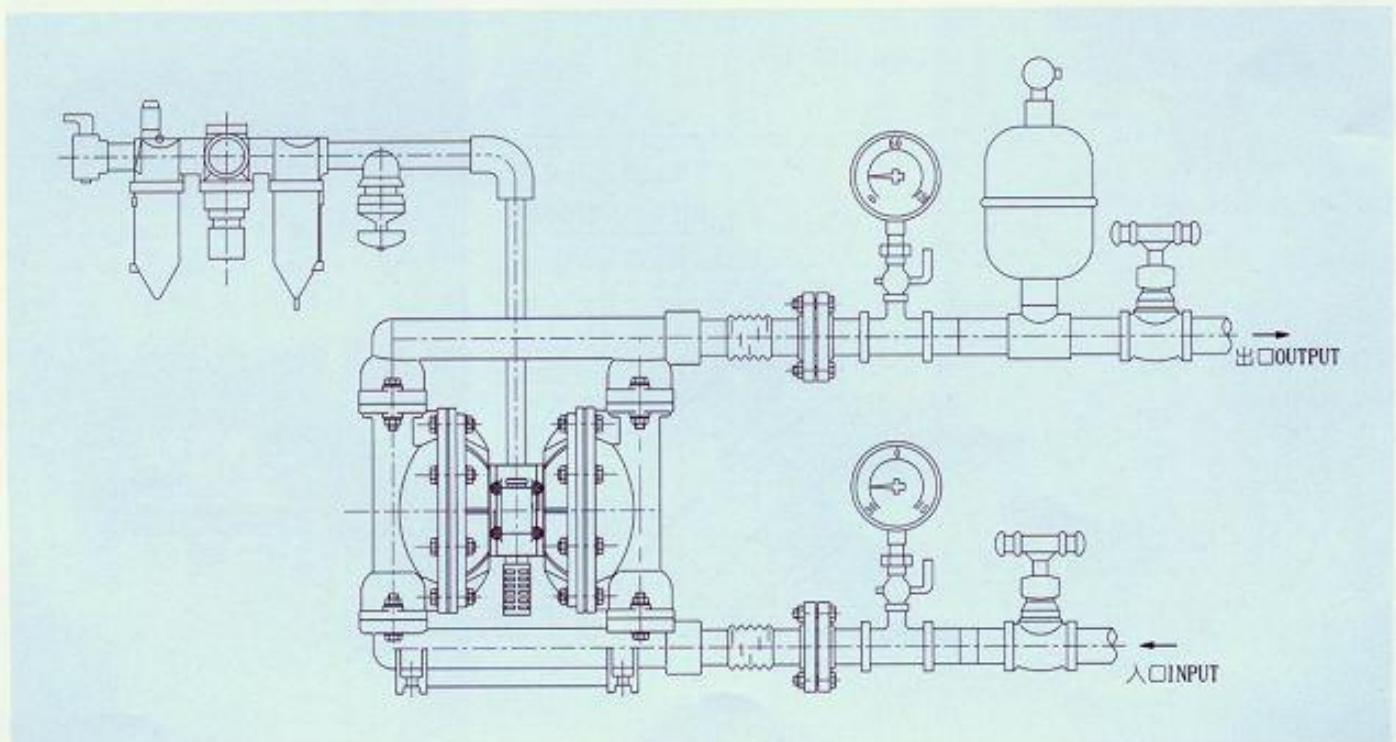

# QBY

## QBY — 10

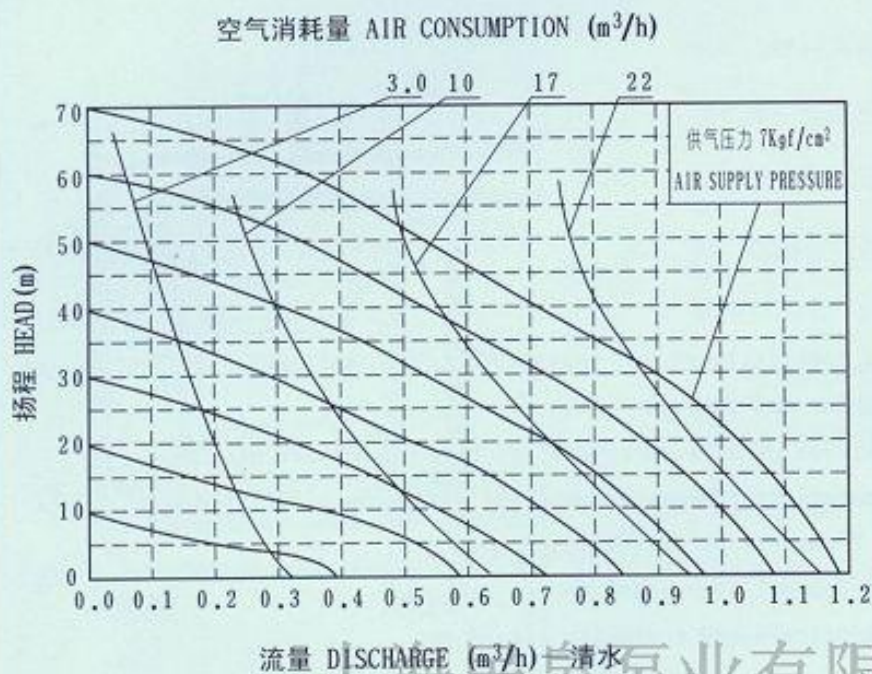

上海民泉泵业有限公司

## QBY — 15

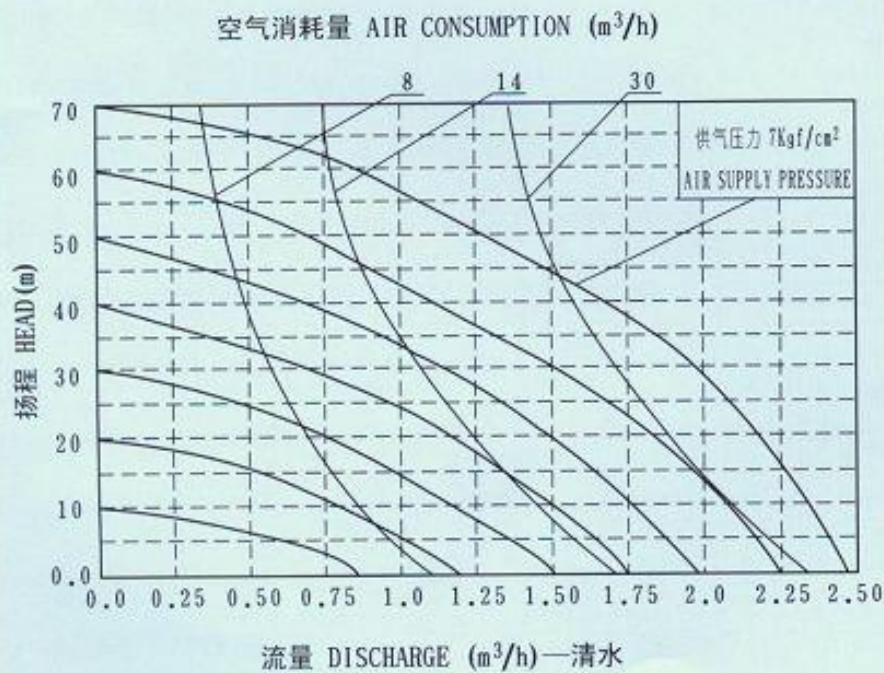

## QBY — 25

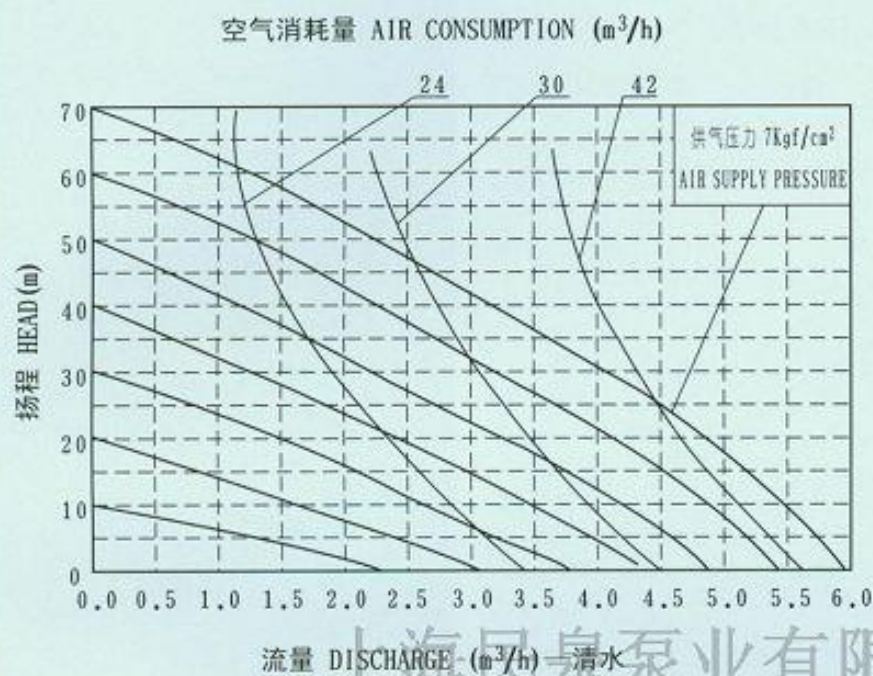

## QBY — 40

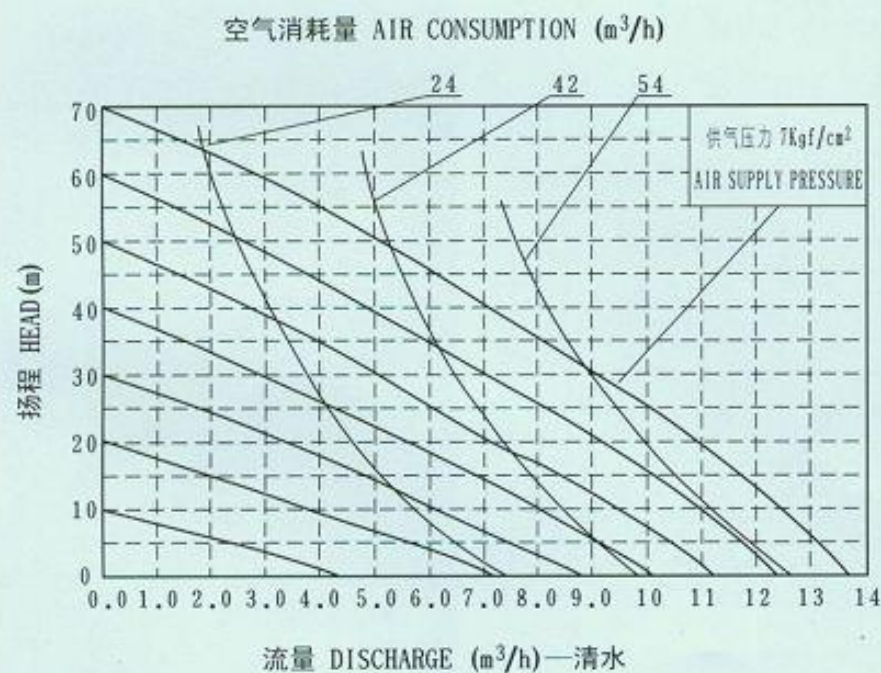

# QBY



## QBY — 50

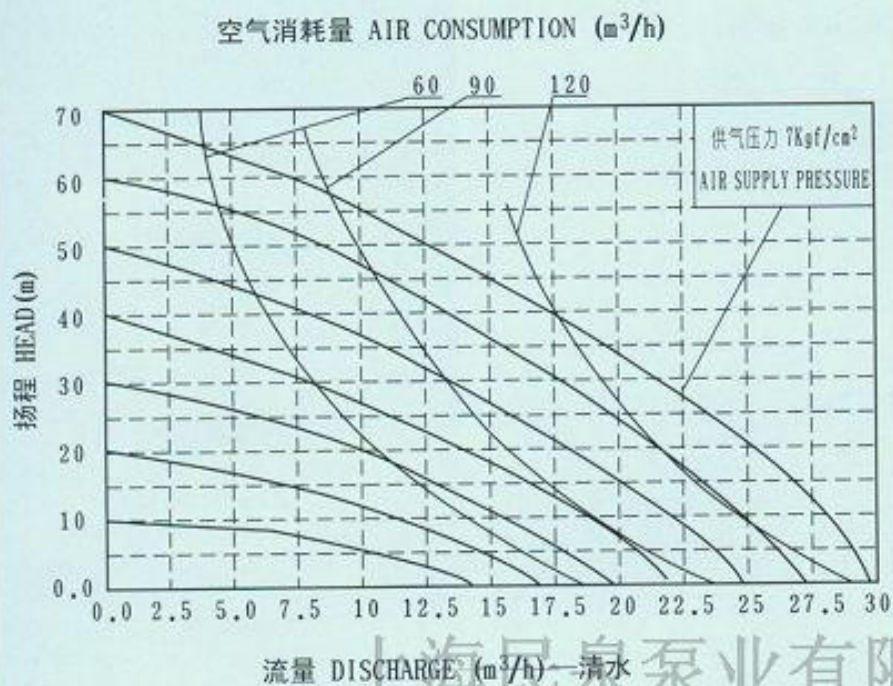

## QBY — 65

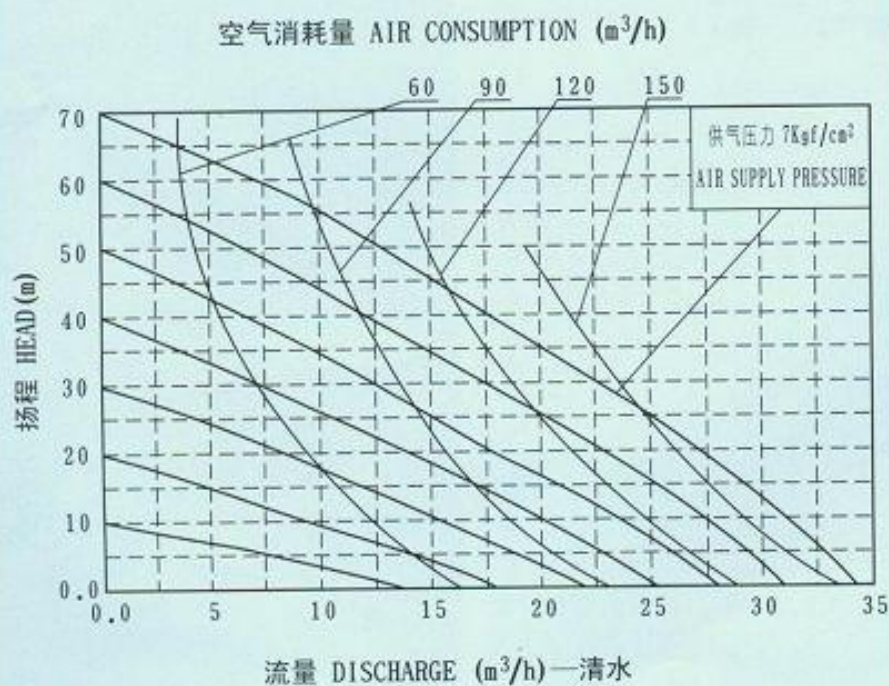



## QBY — 80

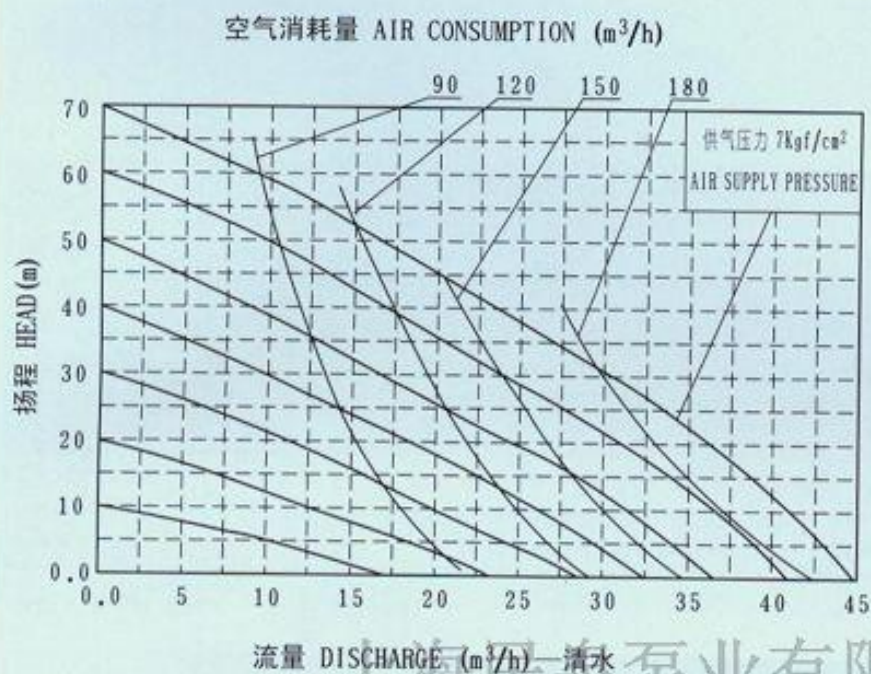

## QBY — 100

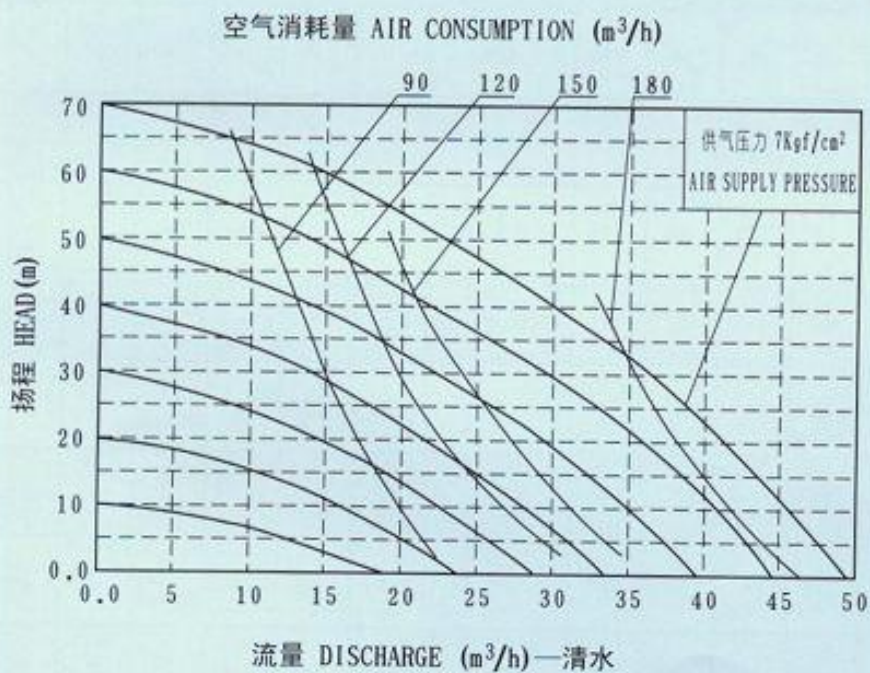

## 安装尺寸图 Drawing of setting data

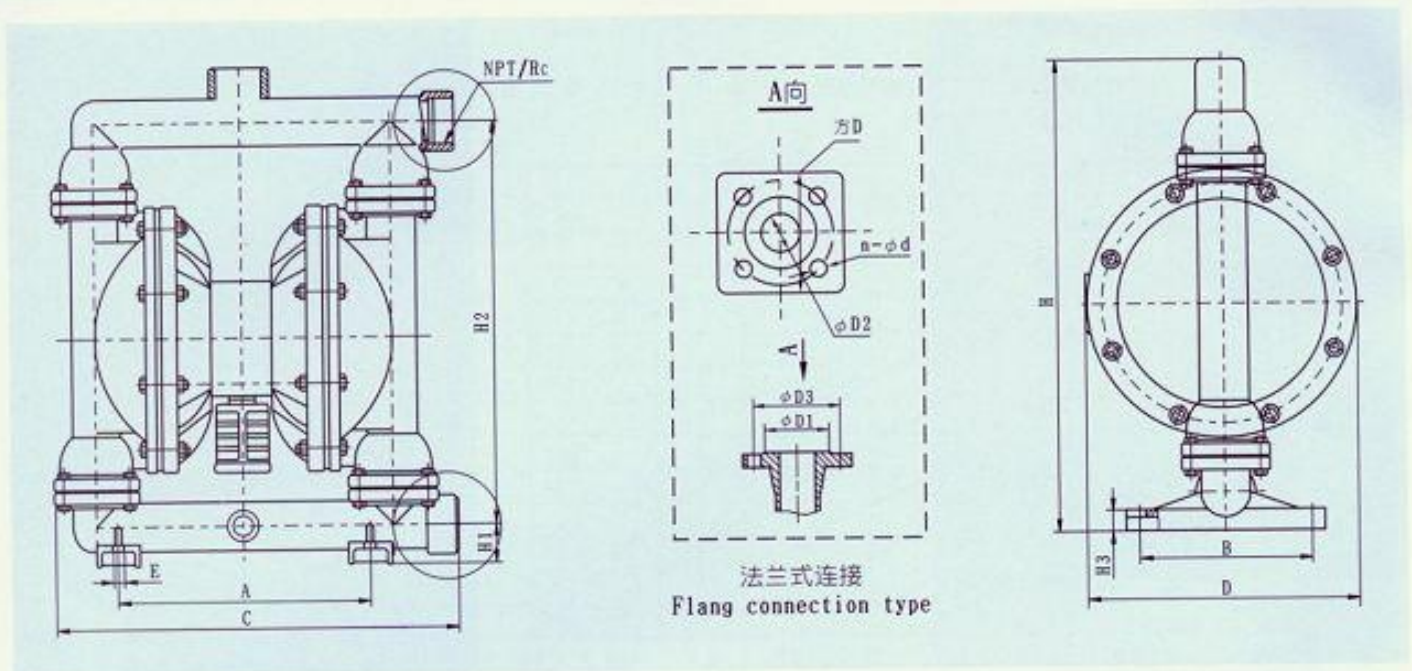

## 安装尺寸表 Tables of setting data 有限公司

型号 Model	A	B	C	D	E	H1	H2	H3	H	螺纹式 Screw	法兰式 Flange					
										NPT/RC	D1	D2	D3	D	n	d
QBY-10	130	50	220	145	10	39	195	10	270	1/2	-	-	-	-	-	-
QBY-15	130	50	220	145	10	39	195	10	270	1/2	-	-	-	-	-	-
QBY-25	245	160	360	250	12	63	360	36	470	1	-	-	-	-	-	-
QBY-40	245	160	360	250	12	63	360	35	470	进1 1/2 出1 1/4	-	-	-	-	-	-
QBY-50	335	220	540	345	16	88	-	25	720	-	90	50	110	方 130×130	4	14
QBY-65	335	220	540	345	16	88	-	25	720	-	110	65	130	方 130×130	4	14
QBY-80	425	250	570	450	18	110	-	32	900	-	125	80	150	方 160×160	4	18
QBY-100	425	250	570	450	18	110	-	32	900	-	145	100	170	方 160×160	4	18

## 性能参数 Performance parameter

型号 Model	流量 Discharge (m <sup>3</sup> /h)	扬程 Head (m)	出口压力 Exit pressure (kgf/cm <sup>2</sup> )	吸程 Sucked lift (m)	最大允许 颗粒直径 Max grain Dia (mm)	最大供 气压力 Max pressure (kgf/cm <sup>2</sup> )	最大空 气消耗量 Max air consumption (m <sup>3</sup> /min)	材 料 Materials				
								铝 ZL104	不锈钢 1Cr18Ni9Ti	铸铁 HT200	增强聚丙烯 Enhanced Polypropylene	过滤部分衬氟 Fluorine-lining in filtered part F46 (EFP), PO
QBY-10	0~0.8	0~50	6	5	1	7	0.3	★	★	★	★	/
QBY-15	0~1	0~50	6	5	1	7	0.3	★	★	★	★	/
QBY-25	0~2.4	0~50	6	7	2.5	7	0.6	★	★	★	★	★
QBY-40	0~8	0~50	6	7	4.5	7	0.6	★	★	★	★	★
QBY-50	0~12	0~50	6	7	8	7	0.9	★	★	★	/	★
QBY-65	0~16	0~50	6	7	8	7	0.9	★	★	★	/	★
QBY-80	0~24	0~50	6	7	10	7	1.5	★	★	★	/	/
QBY-100	0~30	0~50	6	7	10	7	1.5	★	★	★	/	/

Note: ★-有 have /-无 without

上海民泉泵业有限公司

## 安装方式 Installation method

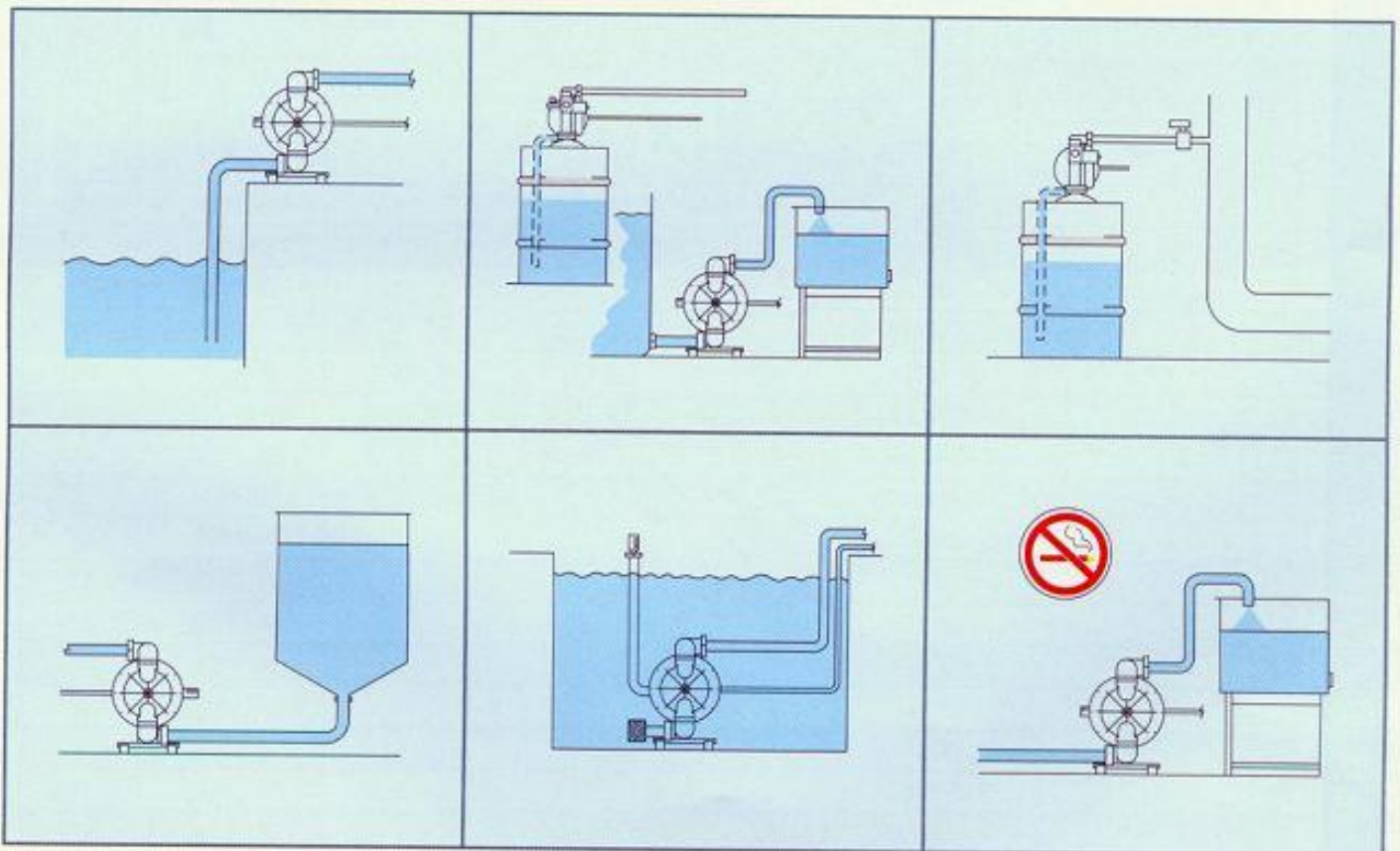

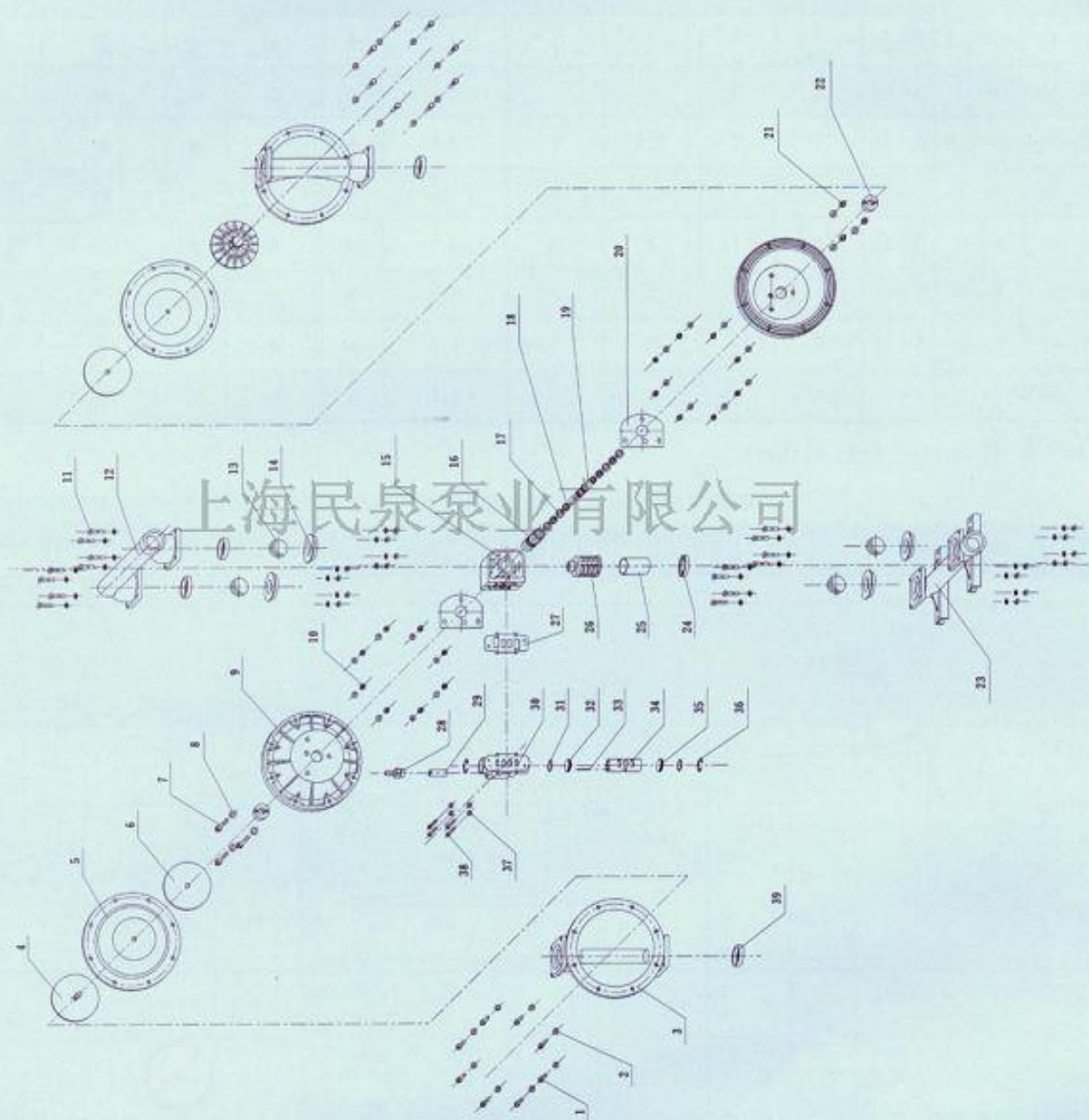

## 零件清单

零件序号	名称	数量	材 料			
1	螺 钉	16	Q235-A			
2	垫 圈	64	Q235-A			
3	立 柱	2	1Cr18Ni9Ti	HT200	ZL104	增强聚丙烯
4	外压板	2	Q235-A			
5	隔 膜	2	丁晴橡胶	氟 橡 胶	氯丁橡胶	
6	内压板	2	ZL104 and Steel			
7	螺 钉	3	Q235-A			
8	垫 圈	6	Q235-A			
9	隔 板	2	ZL104			
10	螺 母	32	Q235-A			
11	螺 钉	16	Q235-A			
12	上 盖	1	1Cr18Ni9Ti	HT200	ZL104	增强聚丙烯
13	球	4	氯丁橡胶	丁晴橡胶	聚四氟乙烯	陶 瓷
14	球 座	4				氟 橡 胶
15	中间泵体	1	ZL104			
16	铜 套	1	H62			
17	O型密封圈	4	聚四氟乙烯			
18	O型密封圈	4	丁晴橡胶			
19	中 间 轴	1	1Cr18Ni9Ti			
20	泵体密封垫	2	耐油橡胶石棉板			
21	螺 母	3	Q235-A			
22	定 位 圈	2	塑 料			
23	底 座	1	1Cr18Ni9Ti	HT200	ZL104	增强聚丙烯
24	消声器盖	1	ABS			
25	消声器体	1	QSn6.5-0.1			
26	消声器套	1	ABS			
27	气阀密封	1	耐油橡胶石棉板			
28	气 接 头	1	Q235-A			
29	进气过滤器	1	烧结黄铜颗粒			
30	配 气 阀	1	ZQSn6-6-3			
31	O 型 圈	2	丁晴橡胶			
32	定位挡片	1	Ly12			
33	起 动 杆	1	H62			
34	活 塞	1	ZL105			
35	定位挡片	1	Ly12			
36	孔用弹性挡圈	2	65Mn			
37	弹簧垫圈	4	65Mn			
38	螺 钉	4	Q235-A			
39	球 座	4	增强聚丙烯			



## Databook of sections

Serial number	Name	Amount	Data			
1	Bolt	16	Q235-A			
2	Gasket 10	64	Q235-A			
3	Stand column	2	1Cr18Ni9Ti	HT200	ZL104	Enhanced polypropylene
4	Outside Platen	2	Q235-A			
5	Dissepiments	2	Nitrile Rubbers	Fluorine Rubber	Chloronorgutta	
6	Endo Platen	2	ZL104 and Steel			
7	Bolt	3	Q235-A			
8	Gasket	6	Q235-A			
9	Clapboard	2	ZL104			
10	Screw Cap M10	32	Q235-A			
11	Bolt	16	Q235-A			
12	Top	1	1Cr18Ni9Ti	HT200	ZL104	Enhanced polypropylene
13	Ball	4	Chloron- orgutta	Nitrile Rubbers	Polytetraflu- oroethylene	Argil
14	Tee	4				Fluorine Rubber
15	Pump Body	1	ZL104			
16	Cuprum Series	1	H62			
17	O-ring Seal	4	Polytetrafluoroethylene			
18	O-ring Seal	4	Nitrile Rubbers			
19	Shaft	1	1Cr18Ni9Ti			
20	Block Gasket	2	Oil-proof rubber rock wool			
21	Screw cap	3	Q235-A			
22	Site-ring	2	Plastic			
23	Bottom	1	1Cr18Ni9Ti	HT200	ZL104	Enhanced polypropylene
24	Muffler Cover	1	ABS			
25	Muffling Coat	1	QSn6.5-0.1			
26	Muffler Body	1	ABS			
27	Air Valve Gasket	1	Oil-proof rubber rock wool			
28	Air Connector	1	Q235-A			
29	Into gases Percolator	1	Sintering brass granule			
30	Air Distributive Valve	1	ZQSn6-6-3			
31	O-ring	2	Nitrile Rubbers			
32	Baffle	1	Ly12			
33	Site billot	1	H62			
34	Piston	1	ZL105			
35	Baffle	1	Ly12			
36	Spring Collar	2	65Mn			
37	Spring Cushion	4	65Mn			
38	Bolt	4	Q235-A			
39	Tee pressure annulus	4	Enhanced polypropylene			

## 几种隔膜材料特性 Characteristic of diaphragm

介质种类 Medium	隔膜品种 Variety	丁腈橡胶 Nitrile Rubber	氯丁橡胶 Chloroprene Rubber	氟橡胶 Fluorine Rubber	聚四氟乙烯 PTFE	食品橡胶 Food Rubber
发烟硝酸	Smoke nitric acid	×	×	△	△	
浓硝酸	Density nitric acid	×	×	△	△	
浓硫酸	Density sulfuric acid	×	×	○	△	
浓盐酸	Density hydrochloric acid	×	△	△	△	
浓磷酸	Density phosphoric acid	×	△	△	△	
浓醋酸	Density acetic acid	×	×	×	△	
浓氢氧化钠	Density sodium hydroxide	○	○	△	△	
无水氨	Non-aqueous ammonia	△	△	△	△	
稀硝酸	Thin nitric acid	×	×	○	△	
稀硫酸	Thin sulfuric acid	△	△	△	△	
稀盐酸	Thin hydrochloric acid	×	○	△	△	
稀磷酸	Thin phosphoric acid	×	×	△	△	
稀氢氧化钠	Thin sodium hydroxide	○	○	△	△	
氨水	Liquid ammonia	△	△	△		
苯	Benzene	×	×	○	○	
汽油	Gasoline	○	○	○	○	
石油	Petroleum	△	×	○	○	
四氯化碳	Carbon tetrachloride	○		○	○	
二硫化碳	Carbon disulphite	○		×	○	
乙醇	Alcohol	○	○	○	○	
丙酮	Acetone	×	△	×	○	
甲酚	Cresol	×	△	△	○	
乙醛	Acetic aldehyde	×	×	△	○	
乙苯	Ethylbenzene	×	×	△	○	
丙烯腈	Acrylonitrile	△	△	×	○	
丁醇	Butanol	○	○	○	○	
丁二烯	Butadiene	○	×	△	○	
苯乙烯	Styrene	×	×	△	○	
醋酸乙酯	Vinyl acetate resin	×	×	×	○	
醚	Ether	×	×	×	○	

注：○——寿命较长、△——寿命一般、×——不可用、本表仅从耐腐蚀性考虑，因聚四氟乙烯弹性比橡胶差，故实际使用寿命因压力、泵行程杂质等因素影响而异。食品橡胶专用于食品饮料行业。

Note: ○—means the long service life, △—means common service life, ×—means use forbidden. This table is only considered from the anti-corrosion. Because the PTFE elasticity is worse than that in rubber. The actual use life will be affected because of the pressure and pump stroke factors. The food rubber specially uses for beverage industries.



QBY气动隔膜泵  
(工程塑料、氟塑料)



QBY气动隔膜泵  
(工程塑料、氟塑料)



QBY气动隔膜泵  
(铸铁、不锈钢、铝合金)



QBY气动隔膜泵  
(铸铁、不锈钢、铝合金)

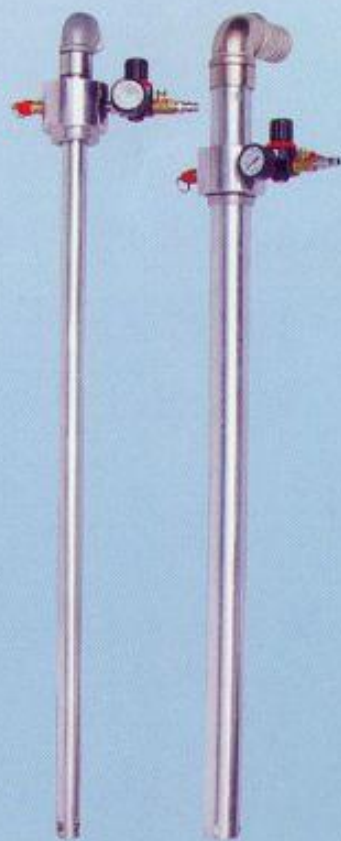
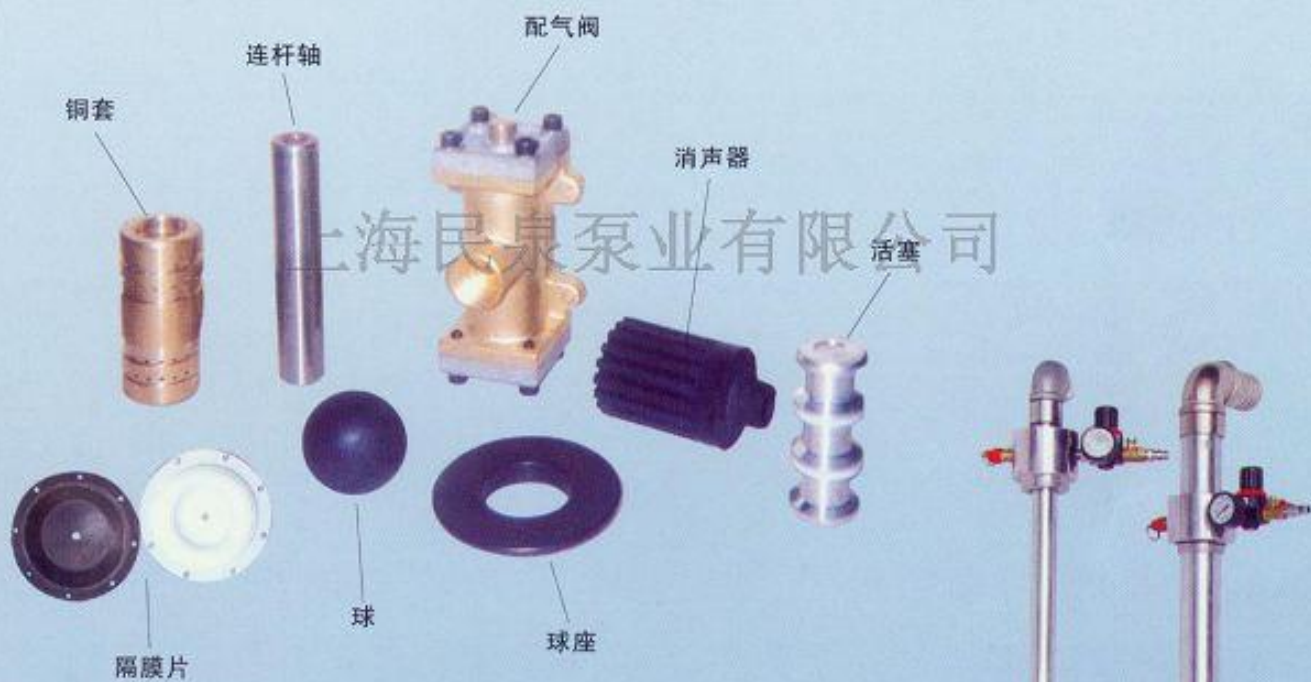

CTB气动插桶泵